

QH Series

Heavy Load Type

2-5 QH Series – Heavy Load Type Linear Guideway, with SynchMotion™ Technology

The development of HIWIN-QH linear guideway is based on a four-row circular-arc contact. The HIWIN-QH series linear guideway with SynchMotion™ Technology offers smooth movement, superior lubrication, quieter operation and longer running life. Therefore the HIWIN-QH linear guideway has broad industrial applicability. In the high-tech industry where high speed, low noise, and reduced dust generation is required, the HIWIN-QH series is interchangeable with the HIWIN-HG series.

2-5-1 Features

(1) Low Noise Design

With SynchMotion™ technology, rolling elements are interposed between the partitions of SynchMotion™ to provide improved circulation. Due to the elimination of contact between the rolling elements, collision noise and sound levels are drastically reduced.

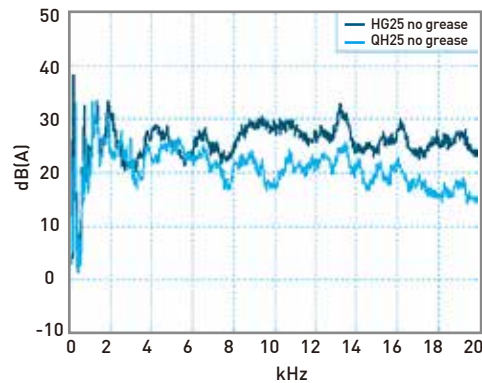
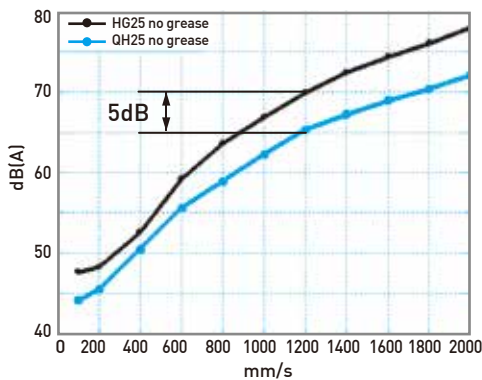

(2) Self-Lubricant Design

The partition is a grouping of hollow ring-like structures formed with a through hole to facilitate circulation of the lubricant. Because of the special lubrication path design, the lubricant of the partition storage space can be refilled. Therefore, the frequency of lubricant refilling can be decreased.

The QH-series linear guideway is pre-lubricated. Performance testing at a 0.2C (basic dynamic load) shows that after running 4,000km no damage was apparent to either the rolling elements or the raceway.

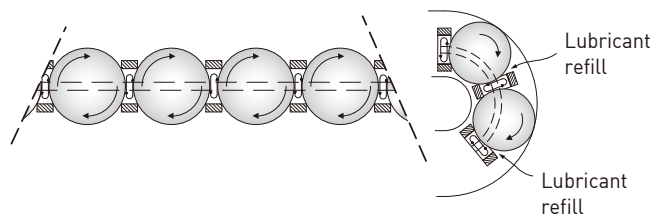

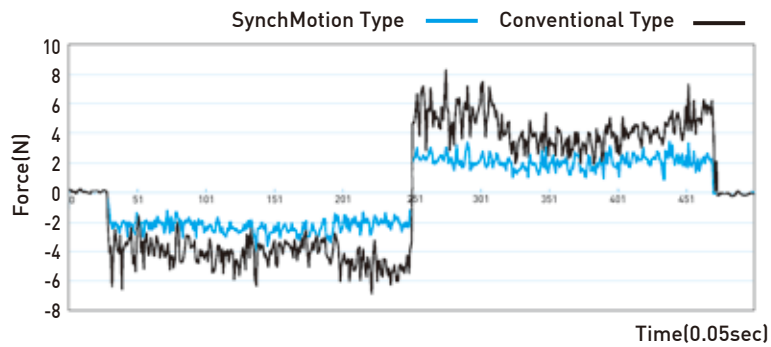

Table 2-5-1 Load Test

Test Sample	QHH25CAZAH	Load Test
Speed	24m/min	 <p>Load=5kN After 4,000km</p>
Lubricant	lithium soap base grease (initial lubrication only)	
Load	5kN	
Distance travel	4,000km	

(3) Smooth Movement

In standard linear guideways, rolling elements on the load side of the guide block begin rolling and push their way through the raceway. When they contact other rolling elements they create counter-rotational friction. This results in a great variation of rolling resistance. The QH linear guideway, with SynchMotion™ technology prevents this condition. As the block starts to move, the rolling elements begin rolling consecutively and remain separated to prevent contact with one another thus keeping the element’s kinetic energy extremely stable in order to effectively reduce fluctuations in rolling resistance.



(4) High Speed Performance

The Hiwin-QH series offers excellent high-speed performance due to the partitions of the SynchMotion™ structure. They are employed to separate the adjacent balls thereby resulting in low rolling traction and the metallic friction between adjacent balls is eliminated.

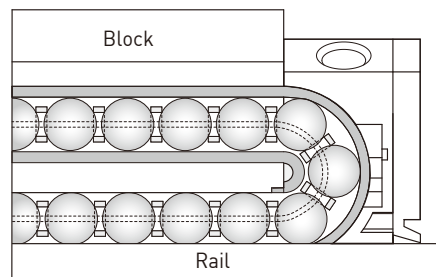

QH Series

Heavy Load Type

Table 2-5-2

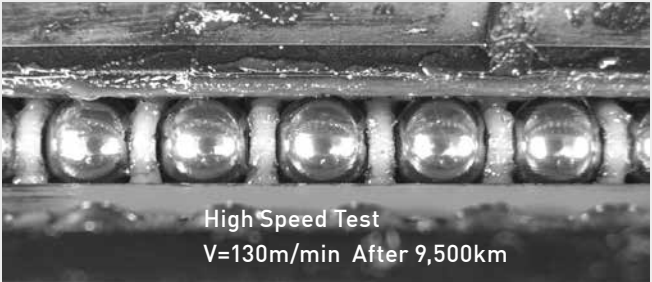
Test Sample	QHW25CAZAH	High Speed Test
Speed	130m/min	 <p>High Speed Test V=130m/min After 9,500km</p>
Lubricant	lithium soap base grease (initial lubrication only)	
Distance travel	9,500km	

2-5-2 Construction

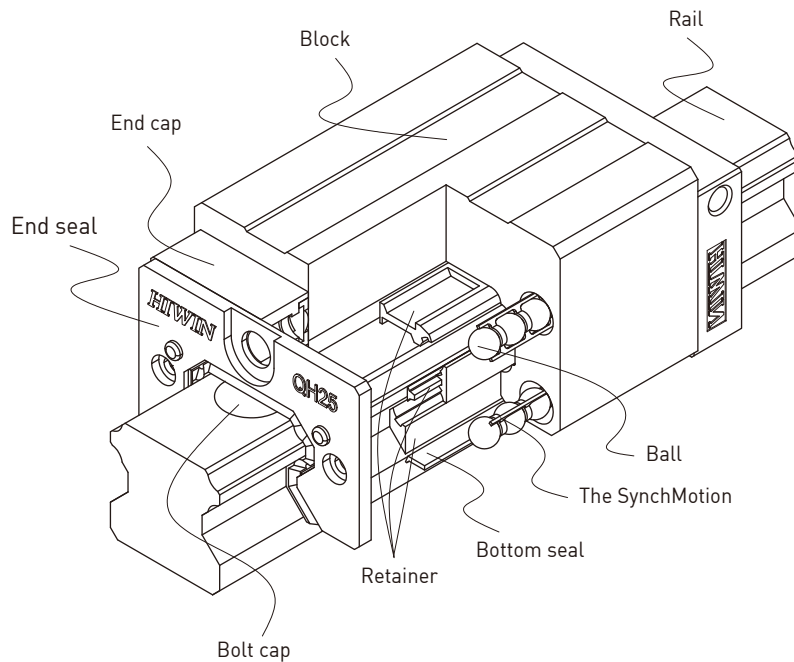

2-5-3 Model Number of QH Series

HIWIN-QH series guideway can be classified into non-interchangeable and interchangeable types. The sizes are identical. The main difference is that the interchangeable blocks and rails can be freely exchanged. Because of dimensional control, the interchangeable type linear guideway is a perfect choice for the client when rails do not need to be paired for an axis. And since the QH and HG share the identical rails, the customer does not need to redesign when choosing the QH series. Therefore the HIWIN-QH linear guideway has increased applicability.

(1) Non-interchangeable type

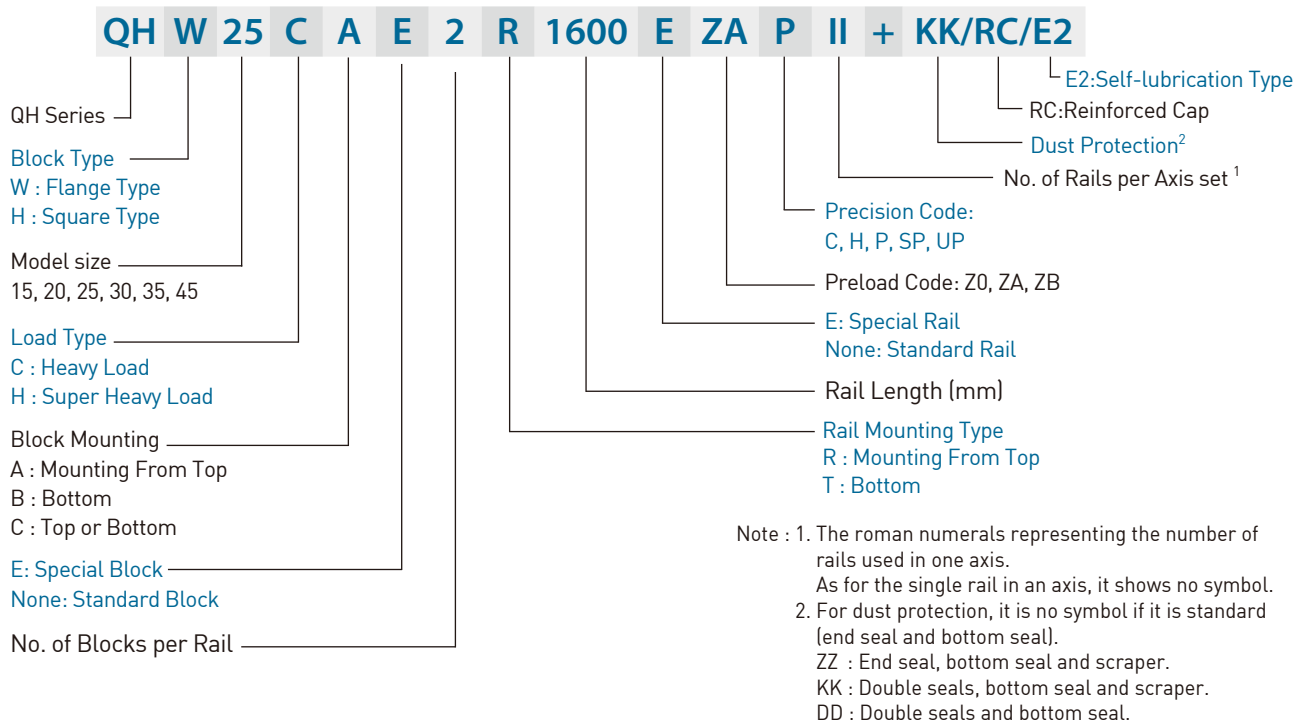

(2) Interchangeable type

○ Model Number of QH Block

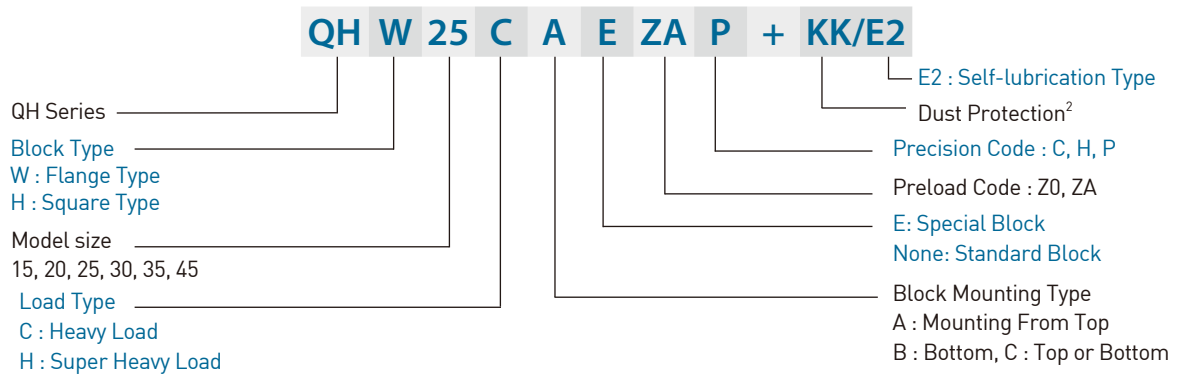

○ Model Number of QH Rail (QH and HG share the identical rails)

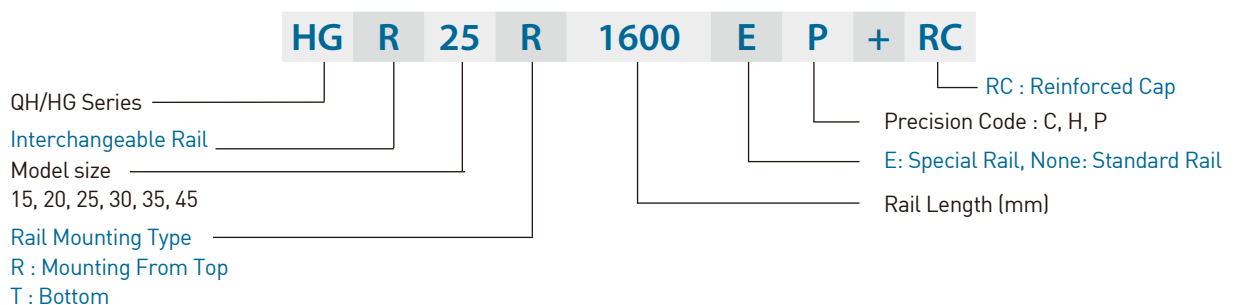

QH Series

Heavy Load Type

2-5-4 Types

(1) Block types

HIWIN offers two types of linear guideways, flange and square types.

Table 2-5-3 Block Types

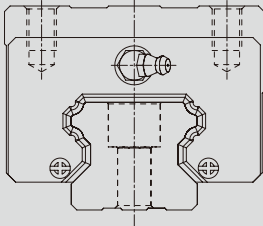
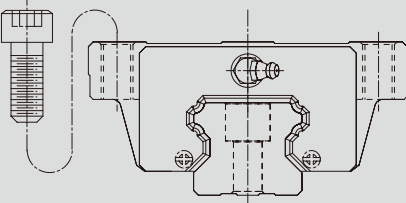
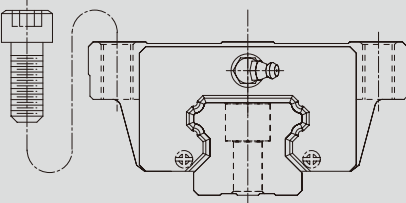
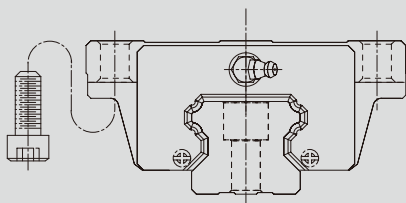
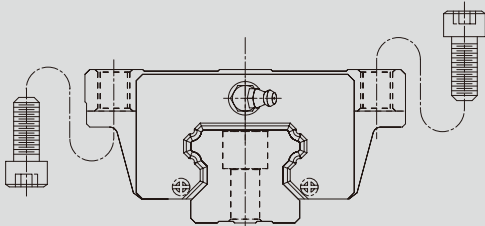
Type	Model	Shape	Height (mm)	Rail Length (mm)	Main Applications
Square	QHH-CA QHH-HA		28	100	<ul style="list-style-type: none"> ○ Automation devices ○ High-speed transportation equipment ○ Precision measuring equipment ○ Semiconductor manufacturing equipment
			↓	↓	
			70	4000	
			↓	↓	
			24	100	
			↓	↓	
			60	4000	
			↓	↓	
Flange	QHW-CA QHW-HA		24	100	
			↓	↓	
			60	4000	
			↓	↓	
			24	100	
			↓	↓	
			60	4000	
			↓	↓	
			24	100	
			↓	↓	
			60	4000	
			↓	↓	

(2) Rail types

Besides the standard top mounting type, the bottom mounting type is also available.

Table 2-5-4 Rail Types

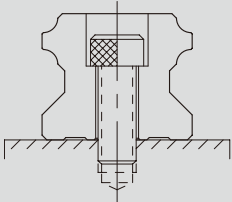
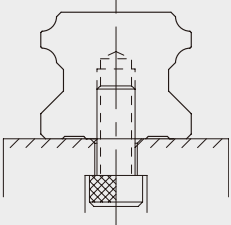
Mounting from Top	Mounting from bottom
	

2-5-5 Accuracy Classes

The accuracy of QH series can be classified into normal (C), high (H), precision (P), super precision (SP), ultra precision (UP), five classes. Please choose the class by referring the accuracy of applied equipment.

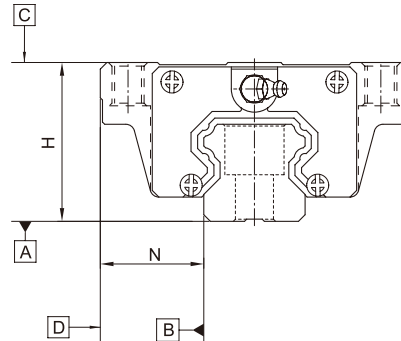

(1) Accuracy of non-interchangeable

Table 2-5-5 Accuracy Standards

Unit: mm

Item	QH - 15, 20				
	Normal (C)	High (H)	Precision (P)	Super Precision (SP)	Ultra Precision (UP)
Dimensional tolerance of height H	± 0.1	± 0.03	0 - 0.03	0 - 0.015	0 - 0.008
Dimensional tolerance of width N	± 0.1	± 0.03	0 - 0.03	0 - 0.015	0 - 0.008
Variation of height H	0.02	0.01	0.006	0.004	0.003
Variation of width N	0.02	0.01	0.006	0.004	0.003
Running parallelism of block surface C to surface A	See Table 2-5-11				
Running parallelism of block surface D to surface B	See Table 2-5-11				

Table 2-5-6 Accuracy Standards

Unit: mm

Item	QH - 25, 30, 35				
	Normal (C)	High (H)	Precision (P)	Super Precision (SP)	Ultra Precision (UP)
Dimensional tolerance of height H	± 0.1	± 0.04	0 - 0.04	0 - 0.02	0 - 0.01
Dimensional tolerance of width N	± 0.1	± 0.04	0 - 0.04	0 - 0.02	0 - 0.01
Variation of height H	0.02	0.015	0.007	0.005	0.003
Variation of width N	0.03	0.015	0.007	0.005	0.003
Running parallelism of block surface C to surface A	See Table 2-5-11				
Running parallelism of block surface D to surface B	See Table 2-5-11				

Table 2-5-7 Accuracy Standards

Unit: mm

Item	QH - 45				
	Normal (C)	High (H)	Precision (P)	Super Precision (SP)	Ultra Precision (UP)
Dimensional tolerance of height H	± 0.1	± 0.05	0 - 0.05	0 - 0.03	0 - 0.02
Dimensional tolerance of width N	± 0.1	± 0.05	0 - 0.05	0 - 0.03	0 - 0.02
Variation of height H	0.03	0.015	0.007	0.005	0.003
Variation of width N	0.03	0.02	0.01	0.007	0.005
Running parallelism of block surface C to surface A	See Table 2-5-11				
Running parallelism of block surface D to surface B	See Table 2-5-11				

QH Series

Heavy Load Type

(2) Accuracy of interchangeable

Table 2-5-8 Accuracy Standards

Unit: mm

Item	QH - 15, 20		
Accuracy Classes	Normal (C)	High (H)	Precision (P)
Dimensional tolerance of height H	± 0.1	± 0.03	± 0.015
Dimensional tolerance of width N	± 0.1	± 0.03	± 0.015
Variation of height H	0.02	0.01	0.006
Variation of width N	0.02	0.01	0.006
Running parallelism of block surface C to surface A	See Table 2-5-11		
Running parallelism of block surface D to surface B	See Table 2-5-11		

Table 2-5-9 Accuracy Standards

Unit: mm

Item	QH - 25, 30, 35		
Accuracy Classes	Normal (C)	High (H)	Precision (P)
Dimensional tolerance of height H	± 0.1	± 0.04	± 0.02
Dimensional tolerance of width N	± 0.1	± 0.04	± 0.02
Variation of height H	0.02	0.015	0.007
Variation of width N	0.03	0.015	0.007
Running parallelism of block surface C to surface A	See Table 2-5-11		
Running parallelism of block surface D to surface B	See Table 2-5-11		

Table 2-5-10 Accuracy Standards

Unit: mm

Item	QH - 45		
Accuracy Classes	Normal (C)	High (H)	Precision (P)
Dimensional tolerance of height H	± 0.1	± 0.05	± 0.025
Dimensional tolerance of width N	± 0.1	± 0.05	± 0.025
Variation of height H	0.03	0.015	0.007
Variation of width N	0.03	0.02	0.01
Running parallelism of block surface C to surface A	See Table 2-5-11		
Running parallelism of block surface D to surface B	See Table 2-5-11		

(3) Accuracy of running parallelism

Table 2-5-11 Accuracy of Running Parallelism

Rail Length (mm)	Accuracy (μm)					
	C	H	P	SP	UP	
~ 100	12	7	3	2	2	
100 ~ 200	14	9	4	2	2	
200 ~ 300	15	10	5	3	2	
300 ~ 500	17	12	6	3	2	
500 ~ 700	20	13	7	4	2	
700 ~ 900	22	15	8	5	3	
900 ~ 1,100	24	16	9	6	3	
1,100 ~ 1,500	26	18	11	7	4	
1,500 ~ 1,900	28	20	13	8	4	
1,900 ~ 2,500	31	22	15	10	5	
2,500 ~ 3,100	33	25	18	11	6	
3,100 ~ 3,600	36	27	20	14	7	
3,600 ~ 4,000	37	28	21	15	7	

2-5-6 Preload

(1) Definition

A preload can be applied to each guideway. Oversized balls are used. Generally, a linear motion guideway has a negative clearance between groove and balls in order to improve stiffness and maintain high precision. The figure shows the load is multiplied by the preload, the rigidity is doubled and the deflection is reduced by one half. The preload no larger than ZA would be recommended for the model size under QH20 to avoid an over-preload affecting the guideway's life.

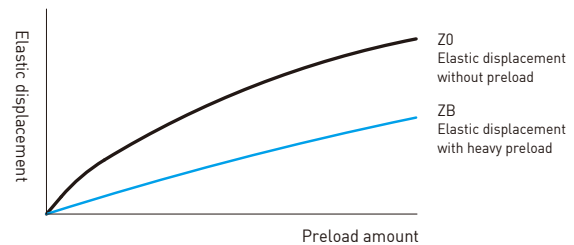

(2) Preload classes

HIWIN offers three classes of standard preload for various applications and conditions.

Table 2-5-12 Preload Classes

Class	Code	Preload	Condition	Examples of Application
Light Preload	Z0	0~ 0.02C	Certain load direction, low impact, low precision required	Transportation devices, auto-packing machines, X-Y axis for general industrial machines, welding machines, welders
Medium Preload	ZA	0.05C~0.07C	High precision required	Machining centers, Z axis for general industrial machines, EDM, NC lathes, Precision X-Y tables, measuring equipment
Heavy Preload	ZB	0.10C~ 0.12C	High rigidity required, with vibration and impact	Machining centers, grinding machines, NC lathes, horizontal and vertical milling machines, Z axis of machine tools, Heavy cutting machines

Class	Interchangeable Guideway	Non-Interchangeable Guideway
Preload classes	Z0, ZA	Z0, ZA, ZB

Note: The "C" in the preload column denotes basic dynamic load rating.

QH Series

Heavy Load Type

2-5-7 Dust Proof Accessories

(1) Codes of accessories

If the following accessories are needed, please add the code followed by the model number.

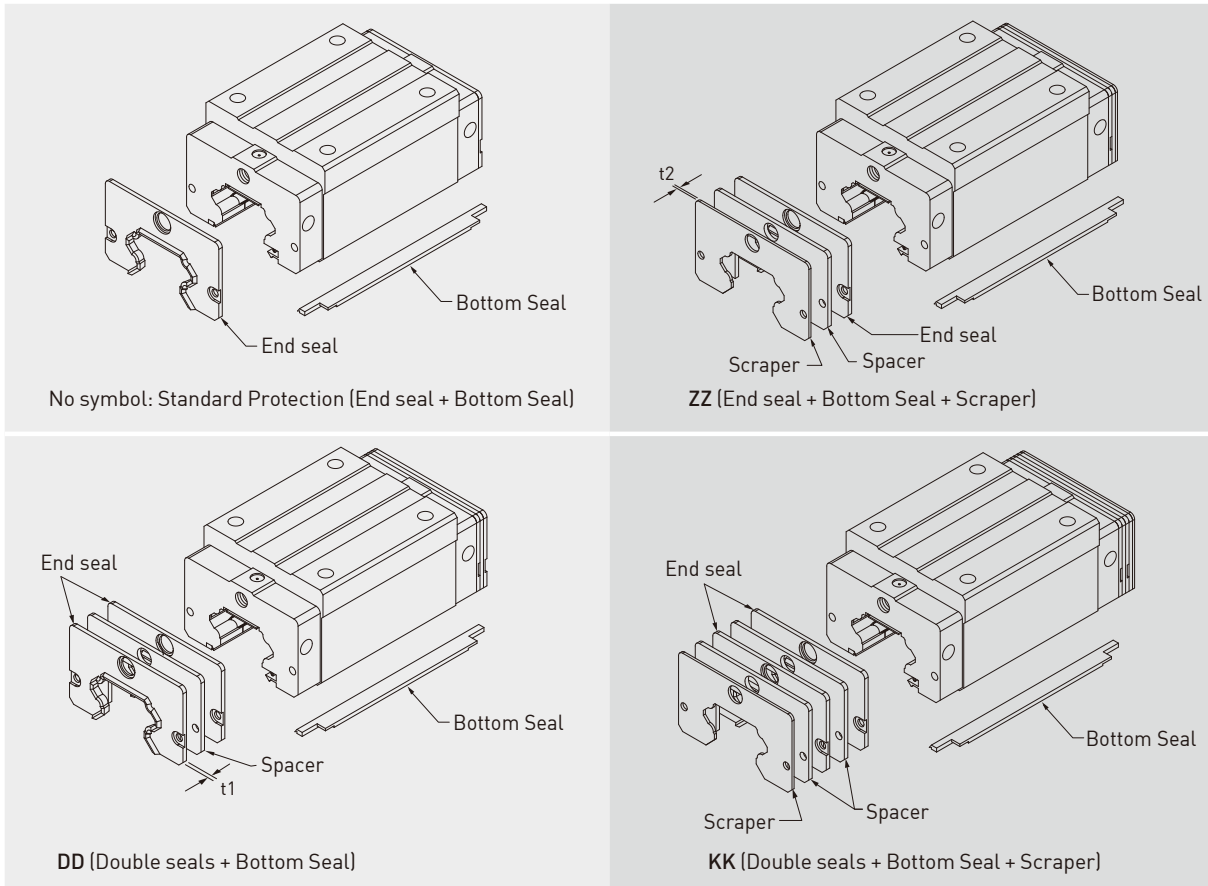

(2) End seal and bottom seal

To prevent life reduction caused by iron chips or dust entering the block.

(3) Double seals

Enhances the wiping effect, foreign matter can be completely wiped off.

Table 2-5-13 Dimensions of end seal

Size	Thickness (t1) (mm)	Size	Thickness (t1) (mm)
QH15 ES	3	QH30 ES	3.2
QH20 ES	2.5	QH35 ES	2.5
QH25 ES	2.5	QH45 ES	3.6

(4) Scraper

The scraper removes high-temperature iron chips and larger foreign objects.

Table 2-5-14 Dimensions of scraper

Size	Thickness (t2) (mm)	Size	Thickness (t2) (mm)
QH15 SC	1.5	QH30 SC	1.5
QH20 SC	1.5	QH35 SC	1.5
QH25 SC	1.5	QH45 SC	1.5

(5) Dimensions of block equipped with the dustproof parts

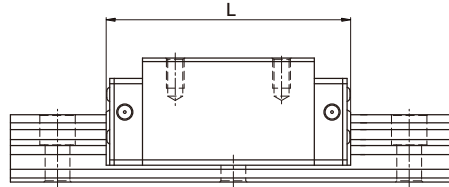

Table 2-5-15 Overall block length

unit: mm

Size	Overall block length (L)			
	SS	ZZ	DD	KK
QH15C	61.4 (61.8)	68.4 (69.4)	68.0 (68.4)	75.0 (76.0)
QH20C	76.7 (78.9)	81.9 (84.5)	81.7 (83.9)	86.9 (89.5)
QH20H	91.4 (93.6)	96.6 (99.2)	96.4 (98.6)	101.6 (104.2)
QH25C	83.4 (86.0)	89.4 (92.0)	88.4 (91.0)	94.4 (97.0)
QH25H	104.0 (106.6)	110.0 (112.6)	109.0 (111.6)	115.0 (117.6)
QH30C	97.4 (99.4)	104.8 (107.4)	104.8 (106.8)	112.2 (114.8)
QH30H	120.4 (122.4)	127.8 (130.4)	127.8 (129.8)	135.2 (137.8)
QH35C	113.6 (114.4)	119.0 (120.0)	118.6 (119.4)	124.0 (125.0)
QH35H	139.4 (140.2)	144.8 (145.8)	144.4 (145.2)	149.8 (150.8)
QH45C	139.4 (139.4)	147.2 (147.2)	146.6 (146.6)	154.4 (154.4)
QH45H	171.2 (171.2)	179.0 (179.0)	178.4 (178.4)	186.2 (186.2)

Note : The marking of "()" denotes the maximum block length with screws, lips of end seals, etc.

QH Series

Heavy Load Type

2-5-8 Friction

The maximum value of seal resistance per block are shown in the table.

Table 2-5-16 Seal Resistance

Size	Resistance N (kgf)
QH15	1.2 (0.12)
QH20	1.6 (0.16)
QH25	2.0 (0.2)
QH30	2.7 (0.27)
QH35	3.1 (0.31)
QH45	5.3 (0.53)

2-5-9 The Accuracy Tolerance of Mounting Surface

(1) The accuracy tolerance of rail-mounting surface

Because of the Circular-arc contact design, the QH linear guideway can compensate for some surface-error on installation and still maintain smooth linear motion.

As long as the accuracy requirements for the mounting surface are followed, high accuracy and rigidity of linear motion of the guideway can be obtained without any difficulty. In order to satisfy the needs of fast installation and smooth movement, HIWIN offers the normal clearance type of preload to customers of its high absorption ability of the deviation in mounting surface accuracy.

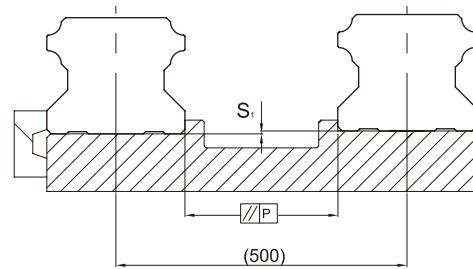

(2) The parallelism tolerance of reference surface

Table 2-5-17 Max. Parallelism Tolerance (P)

unit: μm

Size	Preload classes		
	Z0	ZA	ZB
QH15	25	18	-
QH20	25	20	18
QH25	30	22	20
QH30	40	30	27
QH35	50	35	30
QH45	60	40	35

(3) The accuracy tolerance of reference surface height

Table 2-5-18 Max. Tolerance of Reference Surface Height (S_1)

unit: μm

Size	Preload classes		
	Z0	ZA	ZB
QH15	130	85	-
QH20	130	85	50
QH25	130	85	70
QH30	170	110	90
QH35	210	150	120
QH45	250	170	140

2-5-10 Cautions for Installation

(1) Shoulder heights and fillets

Improper shoulder heights and fillets of mounting surfaces will cause a deviation in accuracy and the interference with the chamfered part of the rail or block. As long as the recommended shoulder heights and fillets are followed, installation inaccuracies should be eliminated.

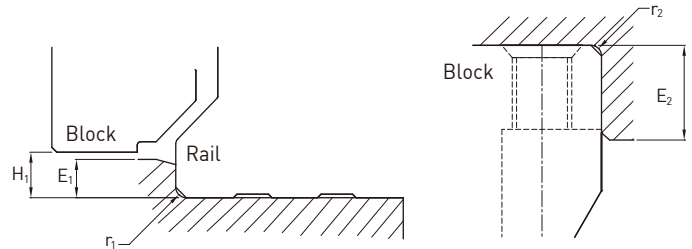

Table 2-5-19 Shoulder Heights and Fillets

Size	Max. radius of fillets r_1 (mm)	Max. radius of fillets r_2 (mm)	Shoulder height of the rail E_1 (mm)	Shoulder height of the block E_2 (mm)	Clearance under block H_1 (mm)
QH15	0.5	0.5	3.0	4.0	4.0
QH20	0.5	0.5	3.5	5.0	4.6
QH25	1.0	1.0	5.0	5.0	5.5
QH30	1.0	1.0	5.0	5.0	6.0
QH35	1.0	1.0	6.0	6.0	7.5
QH45	1.0	1.0	8.0	8.0	9.2

(2) Tightening Torque of Bolts for Installation

Improper tightening of bolts will seriously influence the accuracy of Linear Guideway installation. The following tightening torques for different sizes of bolts are recommended.

Table 2-5-20 Mounting Torque

Size	Bolt size	Torque N-cm(kgf-cm)		
		Iron	Casting	Aluminum
QH15	M4×0.7P×16L	392 (40)	274 (28)	206 (21)
QH20	M5×0.8P×16L	883 (90)	588 (60)	441 (45)
QH25	M6×1P×20L	1373 (140)	921 (94)	686 (70)
QH30	M8×1.25P×25L	3041 (310)	2010 (205)	1470 (150)
QH35	M8×1.25P×25L	3041 (310)	2010 (205)	1470 (150)
QH45	M12×1.75P×35L	11772 (1200)	7840 (800)	5880 (600)

Note : 1 kgf = 9.81 N

QH Series

Heavy Load Type

2-5-11 Dimensions for HIWIN QH Series

(1) QHH-CA / QHH-HA

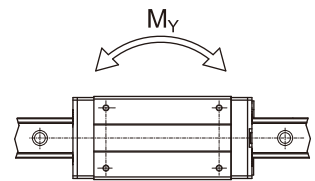
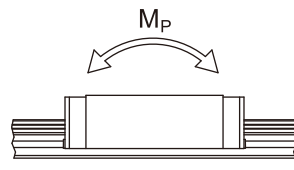
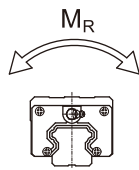
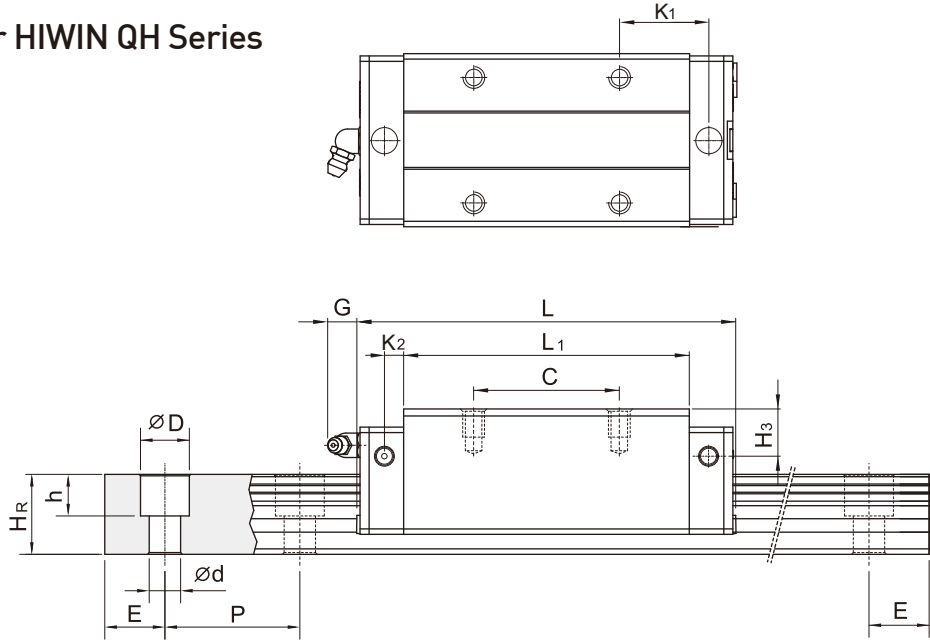
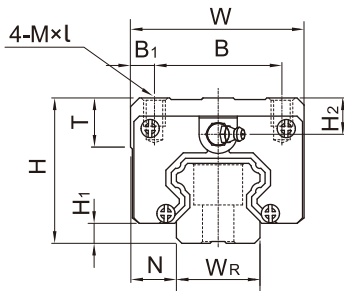

Model No.	Dimensions of Assembly (mm)		Dimensions of Block (mm)													Dimensions of Rail (mm)					Mounting Bolt for Rail (mm)	Basic Dynamic Load Rating C (kN)	Basic Static Load Rating C ₀ (kN)	Static Rated Moment			Weight				
	H	H ₁	N	W	B	B ₁	C	L ₁	L	K ₁	K ₂	G	MxL	T	H ₂	H ₃	W _R	H _R	D	h				d	P	E	M _R (kN-m)	M _P (kN-m)	M _Y (kN-m)	Block (kg)	Rail (kg/m)
	QHH15CA	28	4	9.5	34	26	4	26	39.4	61.4	10	5	5.3	M4 x 5	6	7.95	8.2	15	15	7.5	5.3	4.5	60	20	M4x16	17.94	19.86	0.10	0.08	0.08	0.18
QHH20CA	30	4.6	12	44	32	6	36	50.5	76.7	11.75	6	12	M5 x 6	8	6	6	20	17.5	9.5	8.5	6	60	20	M5x16	30.0	33.86	0.26	0.19	0.19	0.29	2.21
QHH20HA							50	65.2	91.4	12.1															35.7	42.31	0.31	0.27	0.27	0.38	
QHH25CA	40	5.5	12.5	48	35	6.5	35	58	83.4	15.7	6	12	M6 x 8	8	10	9	23	22	11	9	7	60	20	M6x20	41.9	48.75	0.39	0.31	0.31	0.50	3.21
QHH25HA							50	78.6	104	18.5															50.61	60.94	0.50	0.45	0.45	0.68	
QHH30CA	45	6	16	60	40	10	40	70	97.4	19.5	6.25	12	M8x10	8.5	9.5	9	28	26	14	12	9	80	20	M8x25	58.26	66.34	0.60	0.5	0.50	0.87	4.47
QHH30HA							60	93	120.4	21.75															70.32	88.45	0.83	0.89	0.89	1.15	
QHH35CA	55	7.5	18	70	50	10	50	80	113.6	19	7.5	12	M8x12	10.2	15.5	13.5	34	29	14	12	9	80	20	M8x25	78.89	86.66	1.07	0.76	0.76	1.44	6.30
QHH35HA							72	105.8	139.4	20.9															95.23	115.55	1.45	1.33	1.33	1.90	
QHH45CA	70	9.2	20.5	86	60	13	60	97	139.4	23	10	12.9	M10x17	16	18.5	20	45	38	20	17	14	105	22.5	M12x35	119.4	135.42	1.83	1.38	1.38	2.72	10.41
QHH45HA							80	128.8	171.2	29.09															144.13	180.56	2.47	2.41	2.41	3.59	

Note : 1 kgf = 9.81 N

(2) QHW-CA / QHW-HA

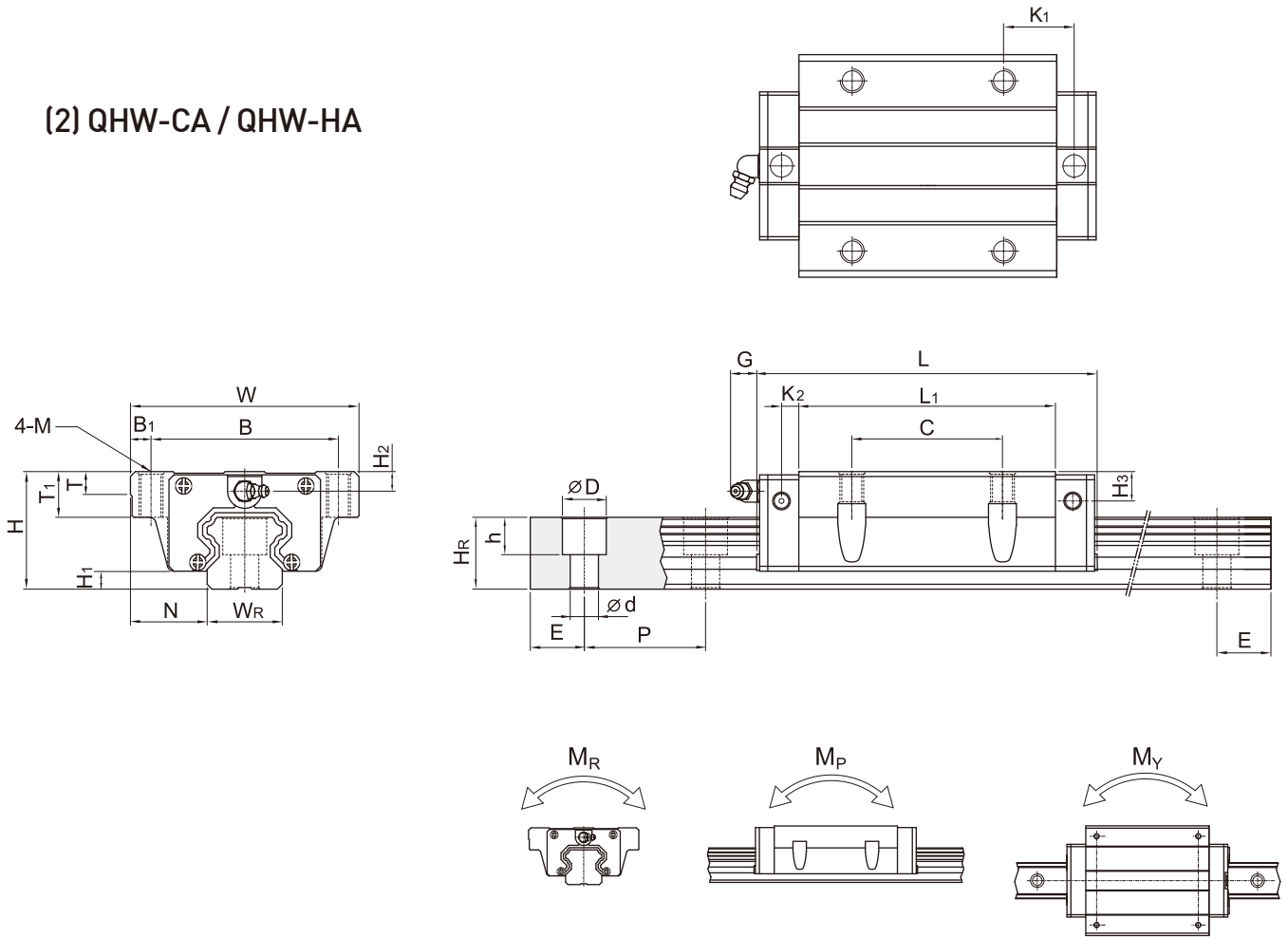

Model No.	Dimensions of Assembly (mm)		Dimensions of Block (mm)													Dimensions of Rail (mm)							Mounting Bolt for Rail (mm)	Basic Dynamic Load Rating C1 (kN)	Basic Static Load Rating C0 (kN)	Static Rated Moment			Weight			
	H	H1	N	W	B	B1	C	L1	L	K1	K2	G	M	T	T1	H2	H3	WR	HR	D	h	d				P	E	MR	MP	MY	Block	Rail
	mm	mm	mm	mm	mm	mm	mm	mm	mm	mm	mm	mm	mm	mm	mm	mm	mm	mm	mm	mm	mm	mm				mm	mm	kN-m	kN-m	kN-m	kg	kg/m
QHW15CA	24	4	16	47	38	4.5	30	39.4	61.4	8	5	5.3	M5	6	8.9	3.95	4.2	15	15	7.5	5.3	4.5	60	20	M4x16	17.94	19.86	0.1	0.08	0.08	0.17	1.45
QHW20CA	30	4.6	21.5	63	53	5	40	50.5	76.7	9.75	6	12	M6	8	10	6	6	20	17.5	9.5	8.5	6	60	20	M5x16	30.0	33.86	0.26	0.19	0.19	0.40	2.21
QHW20HA								65.2	91.4	17.1																35.7	42.31	0.31	0.27	0.27	0.52	
QHW25CA	36	5.5	23.5	70	57	6.5	45	58	83.4	10.7	6	12	M8	8	14	6	5	23	22	11	9	7	60	20	M6x20	41.9	48.75	0.39	0.31	0.31	0.59	3.21
QHW25HA								78.6	104	21																50.61	60.94	0.5	0.45	0.45	0.80	
QHW30CA	42	6	31	90	72	9	52	70	97.4	13.5	6.25	12	M10	8.5	16	6.5	6	28	26	14	12	9	80	20	M8x25	58.26	66.34	0.6	0.5	0.5	1.09	4.47
QHW30HA								93	120.4	25.75																70.32	88.45	0.83	0.89	0.89	1.44	
QHW35CA	48	7.5	33	100	82	9	62	80	113.6	13	7.5	12	M10	10.1	18	8.5	6.5	34	29	14	12	9	80	20	M8x25	78.89	86.66	1.07	0.76	0.76	1.56	6.30
QHW35HA								105.8	139.4	25.9																95.23	115.55	1.45	1.33	1.33	2.06	
QHW45CA	60	9.2	37.5	120	100	10	80	97	139.4	13	10	12.9	M12	15.1	22	8.5	10	45	38	20	17	14	105	22.5	M12x35	119.4	135.42	1.83	1.38	1.38	2.79	10.41
QHW45HA								128.8	171.2	28.9																144.13	180.56	2.47	2.41	2.41	3.69	

Note : 1 kgf = 9.81 N

QH Series

Heavy Load Type

(3) QHW-CB / QHW-HB

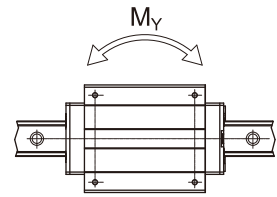
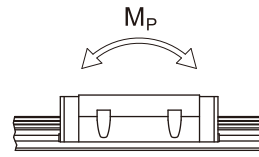
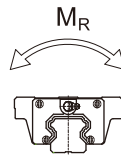
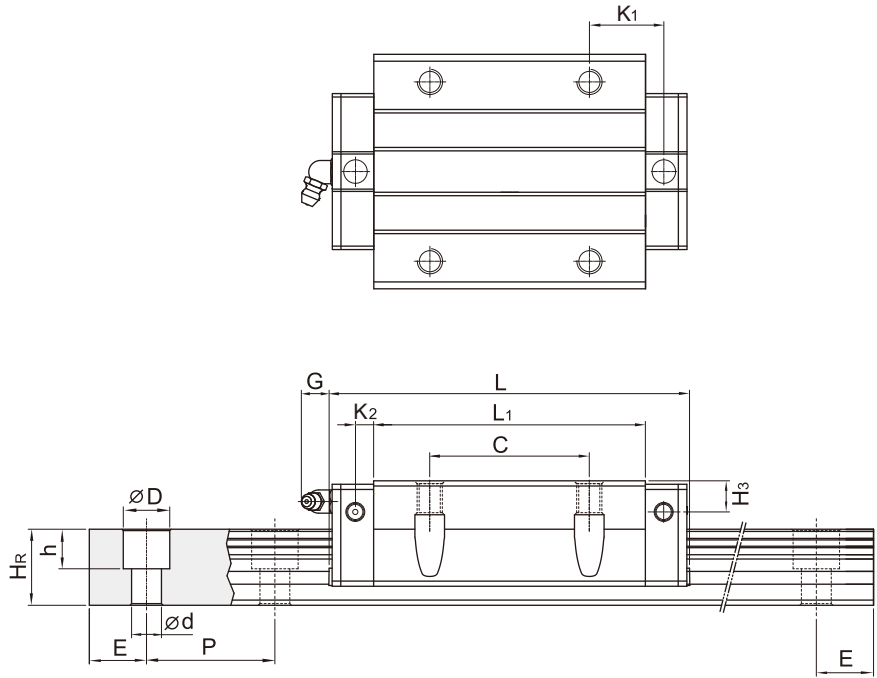
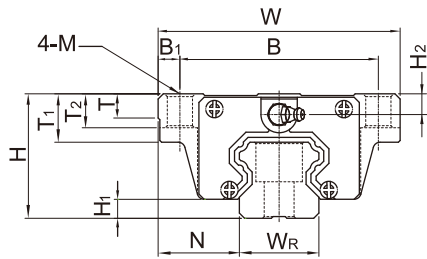

Model No.	Dimensions of Assembly (mm)		Dimensions of Block (mm)														Dimensions of Rail (mm)					Mounting Bolt for Rail (mm)	Basic Dynamic Load Rating C (kN)	Basic Static Load Rating C ₀ (kN)	Static Rated Moment			Weight						
	H	H ₁	N	W	B	B ₁	C	L ₁	L	K ₁	K ₂	G	M	T	T ₁	T ₂	H ₂	H ₃	W _R	H _R	D				h	d	P	E	M _R	M _P	M _Y	Block	Rail	
	mm	mm	mm	mm	mm	mm	mm	mm	mm	mm	mm	mm	mm	mm	mm	mm	mm	mm	mm	mm	mm				mm	mm	mm	mm	mm	kN-m	kN-m	kN-m	kg	kg/m
QHW15CB	24	4	16	47	38	4.5	30	39.4	61.4	8	5	5.3	04.5	6	8.9	6.95	3.95	4.2	15	15	7.5	5.3	4.5	60	20	M4x16	17.94	19.86	0.1	0.08	0.08	0.17	1.45	
QHW20CB	30	4.6	21.5	63	53	5	40	50.5	76.7	9.75																								
QHW20HB								65.2	91.4	17.1	6	12	06	8	10	9.5	6	6	20	17.5	9.5	8.5	6	60	20	M5x16	35.7	42.31	0.31	0.27	0.27	0.52	2.21	
QHW25CB	36	5.5	23.5	70	57	6.5	45	58	83.4	10.7																								
QHW25HB								78.6	104	21	6	12	07	8	14	10	6	5	23	22	11	9	7	60	20	M6x20	41.9	48.75	0.39	0.31	0.31	0.59	3.21	
QHW30CB	42	6	31	90	72	9	52	70	97.4	13.5																								
QHW30HB								93	120.4	25.75	6.25	12	09	8.5	16	10	6.5	6	28	26	14	12	9	80	20	M8x25	58.26	66.34	0.6	0.5	0.5	1.09	4.47	
QHW35CB	48	7.5	33	100	82	9	62	80	113.6	13																								
QHW35HB								105.8	139.4	25.9	7.5	12	09	10.1	18	13	8.5	6.5	34	29	14	12	9	80	20	M8x25	78.89	86.66	1.07	0.76	0.76	1.56	6.30	
QHW45CB	60	9.2	37.5	120	100	10	80	97	139.4	13																								
QHW45HB								128.8	171.2	28.9	10	12.9	011	15.1	22	15	8.5	10	45	38	20	17	14	105	22.5	M12x35	119.4	135.42	1.83	1.38	1.38	2.79	10.41	

Note : 1 kgf = 9.81 N

(4) QHW-CC / QHW-HC

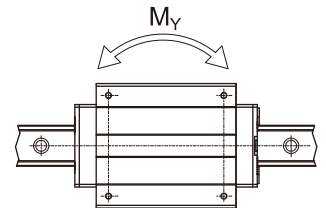
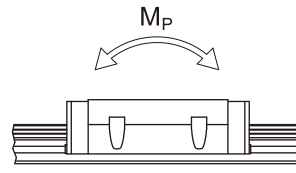
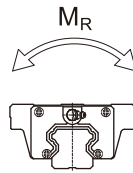
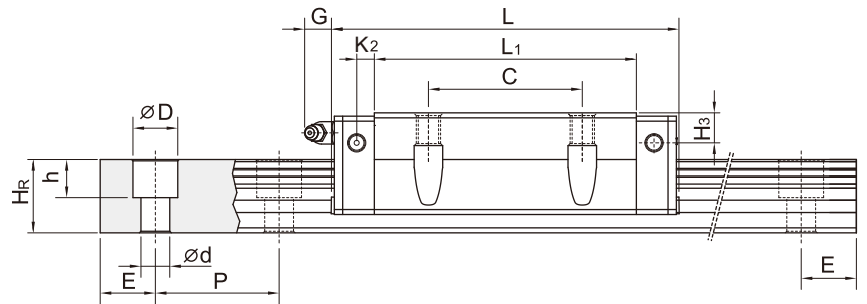
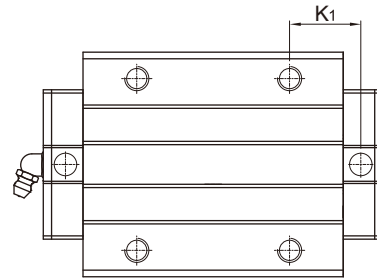
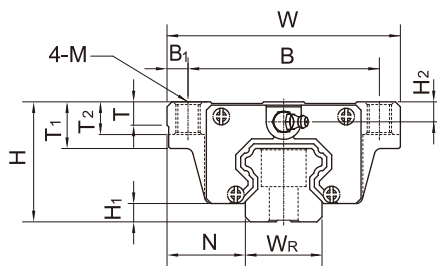

Model No.	Dimensions of Assembly (mm)			Dimensions of Block (mm)													Mounting Bolt for Rail (mm)	Basic Dynamic Load Rating C ₀ (kN)	Basic Static Load Rating C ₀ (kN)	Static Rated Moment			Weight												
	H	H ₁	N	W	B	B ₁	C	L ₁	L	K ₁	K ₂	G	M	T	T ₁	T ₂				H ₂	H ₃	W _R	H _R	D	h	d	P	E	M _R	M _P	M _Y	Block	Rail		
	kgf	kgf	kgf	kgf	kgf	kgf	kgf	kgf	kgf	kgf	kgf	kgf	kgf	kgf	kgf	kgf				kgf	kgf	kgf	kgf	kgf	kgf	kgf	kgf	kgf	kgf	kgf	kgf	kgf	kgf		
QHW15CC	24	4	16	47	38	4.5	30	39.4	61.4	8	5	5.3	M5	6	8.9	6.95	3.95	4.2	15	15	7.5	5.3	4.5	60	20	M4x16	17.94	19.86	0.1	0.08	0.08	0.17	1.45		
QHW20CC	30	4.6	21.5	63	53	5	40	50.5	76.7	9.75	6	12	M6	8	10	9.5	6	6	20	17.5	9.5	8.5	6	60	20	M5x16	30.0	33.86	0.26	0.19	0.19	0.40	2.21		
QHW20HC								65.2	91.4	17.1																									
QHW25CC	36	5.5	23.5	70	57	6.5	45	58	83.4	10.7	6	12	M8	8	14	10	6	5	23	22	11	9	7	60	20	M6x20	41.9	48.75	0.39	0.31	0.31	0.59	3.21		
QHW25HC								78.6	104	21																									
QHW30CC	42	6	31	90	72	9	52	70	97.4	13.5	6.25	12	M10	8.5	16	10	6.5	6	28	26	14	12	9	80	20	M8x25	58.26	66.34	0.6	0.5	0.5	1.09	4.47		
QHW30HC								93	120.4	25.75																									
QHW35CC	48	7.5	33	100	82	9	62	80	113.6	13	7.5	12	M10	10.1	18	13	8.5	6.5	34	29	14	12	9	80	20	M8x25	78.89	86.66	1.07	0.76	0.76	1.56	6.30		
QHW35HC								105.8	139.4	25.9																									
QHW45CC	60	9.2	37.5	120	100	10	80	97	139.4	13	10	12.9	M12	15.1	22	15	8.5	10	45	38	20	17	14	105	22.5	M12x35	119.4	135.42	1.83	1.38	1.38	2.79	10.41		
QHW45HC								128.8	171.2	28.9																									

Note : 1 kgf = 9.81 N